



■ GEBERIT

MORE THAN **JUST BEAUTIFUL**

MRP VALID FROM JULY 2021

DESIGN
MEETS
FUNCTION

STRIKING SIMPLICITY

PURE DESIGN

GEBERIT'S SWISS TECHNOLOGY HAS BEEN TRUSTED FOR MORE THAN 140 YEARS

Geberit has been among the pioneers of the industry and still is setting trends with comprehensive solutions. More than 12,000 employees with representatives in 50 countries are helping to set new standards. Specifically for the requirements of the Indian market, Geberit developed the Alpha line.

THE GEBERIT ALPHA RANGE

The various actuator options, perfectly balance design and environmental friendliness.

↓ ALPHA50 ↓ ALPHA30 ↓ ALPHA15 ↓ ALPHA10



Geberit Alpha actuator plates come in four designs in three different finishes

GEBERIT CONCEALED SOLUTIONS

THE TRADITION OF HIDING CISTERNS

- More than 50 years experience in the field of concealed cisterns.
- Over 1 million installed cisterns in India and 60 million installed cisterns world wide.
- Seamless cisterns, individually inspected and guaranteed to be leakproof.
- Wide design range of actuator plates.



↑ Introducing the first concealed cistern in 1964

THE GEBERIT ADVANTAGE

- ★★★★ PREMIUM QUALITY
- 🧼 EASY TO CLEAN
- 🏗️ 400 kg CONSTRUCTION WITHSTANDS WEIGHTS OF 400 KG
- 🔧 EASY MAINTENANCE OF ALL FUNCTIONAL PARTS
- 💧 6L WATER SAVING UP TO 60% BY DUAL TECHNOLOGY
- ⚙️ 25 YEARS OF SPARE PARTS AVAILABILITY



↑ Current state of modern technology

GOOD REASONS FOR THE GEBERIT KOMBIFIX

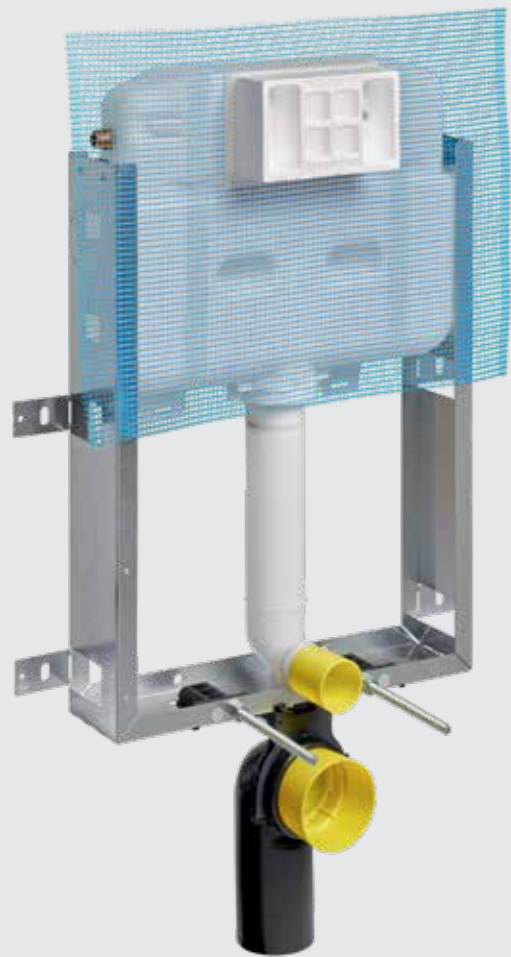

10 years warranty
 साल वारंती
 ans de garantie
 anni di garanzia
 jaar garantie
 años de garantía
 → www.geberit.in
 For concealed cisterns



BRICK WALL SOLUTION
 → Easy to install
 → Connection points pre-marked
 → Distance between flush bend and drainage pipe fixed
 → All fastening material included



STABLE AND STRONG FRAME
 → Designed to hold 400 kg



EASY MAINTENANCE
 → Easy to service
 → 10 years guarantee
 → 25 years spare parts availability

ALL INCLUSIVE

The complete fastening material is included in the scope of delivery.
 No need to organise an additional drainage bend or a chair bracket for the fixation of the wall-hung WC.

**All in
 one box**

 ↑ HDPE WC connection set	 ↑ HDPE connector bend and adapter sleeve	 ↑ HDPE inlet connector with lip seal
 ↑ HDPE connection clips	 ↑ Galvanized steel rods	 ↑ Nuts and covers

GOOD REASONS FOR THE GEBERIT DUOFIX



10 years warranty
 साल वारंती
 ans de garantie
 anni di garanzia
 jaar garantie
 años de garantía
 → www.geberit.in
 For concealed cisterns

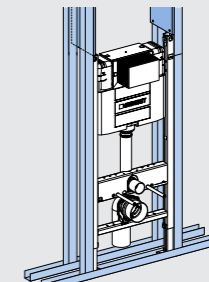

DRY WALL SOLUTION
 → Fast and easy to install
 → Can be installed in partition walls
 → Stable strong frame to withstand up to 400 kg
 → Simple maintenance

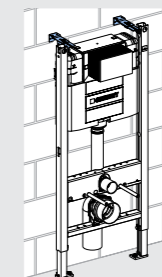

SOLID WALL SOLUTION
 → Can be installed in front of a solid wall
 → Wall anchoring set for solid walls included

ALL INCLUSIVE

The complete fastening material is included in the scope of delivery.
 No need to organise an additional drainage bend or a chair bracket for the fixation of the wall-hung WC.

**All in
 one box**

 ↑ HDPE WC connection set	 ↑ HDPE connector bend and adapter sleeve	 ↑ HDPE inlet connector with lip seal	 ↑ HDPE connection clips
 ↑ Galvanized steel rods	 ↑ Screws and dowel	 ↑ Nuts and covers	

GEBERIT ALPHA ACTUATOR PLATES

FRONT ACTUATION

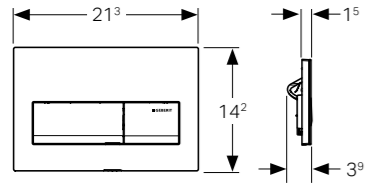

ALPHA50, WHITE



Article No.: 115.060.11.1
MRP: ₹7,900

**ALPHA50,
JET BLACK RAL 9005**



Article No.: 115.060.DW.1
MRP: ₹7,900

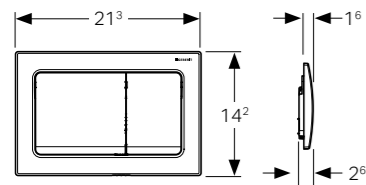

ALPHA30, WHITE



Article No.: 115.055.11.1
MRP: ₹4,700

**ALPHA30,
MATT CHROME**



Article No.: 115.055.46.1
MRP: ₹6,300

**ALPHA30,
BRIGHT CHROME**



Article No.: 115.055.21.1
MRP: ₹6,300

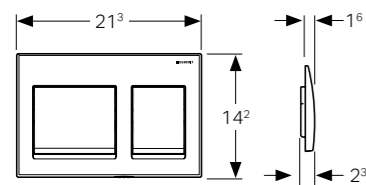

ALPHA15, WHITE



Article No.: 115.045.11.2
MRP: ₹2,000

**ALPHA15,
MATT CHROME**



Article No.: 115.045.46.2
MRP: ₹2,400

**ALPHA15,
BRIGHT CHROME**



Article No.: 115.045.21.2
MRP: ₹2,400

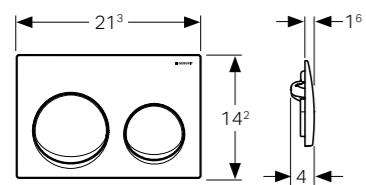

ALPHA10, WHITE



Article No.: 115.040.11.1
MRP: ₹2,000

**ALPHA10,
MATT CHROME**



Article No.: 115.040.46.1
MRP: ₹2,200

**ALPHA10,
BRIGHT CHROME**



Article No.: 115.040.21.1
MRP: ₹2,200

The visible highlights are the beautiful dual-flush Alpha10, Alpha15, Alpha30 and Alpha50 actuator plates and are available in white, matt chrome, bright chrome and jet black.

GEBERIT ALPHA CONCEALED CISTERNS

GEBERIT ALPHA NAKED - 109.010.00.1

MRP: ₹ 5,900

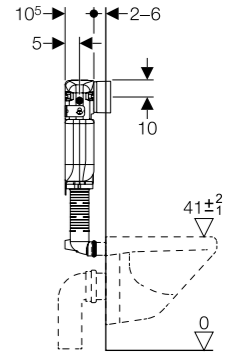
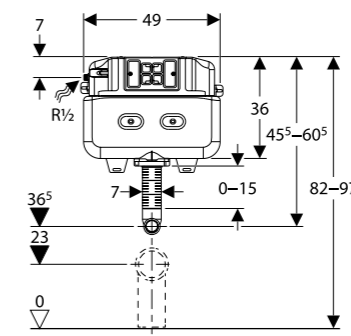

GEBERIT ALPHA KOMBIFIX - 110.120.00.1

MRP: ₹ 9,120

All in one box

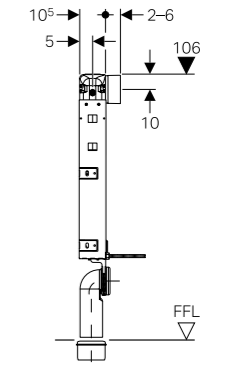
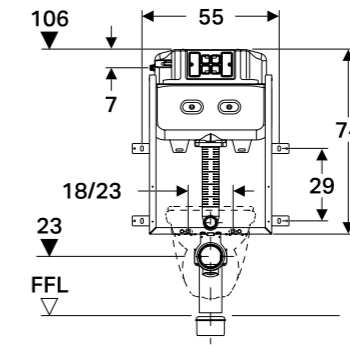

GEBERIT ALPHA DUOFIX - 458.233.00.1

MRP: ₹ 13,000

NEW

All in one box

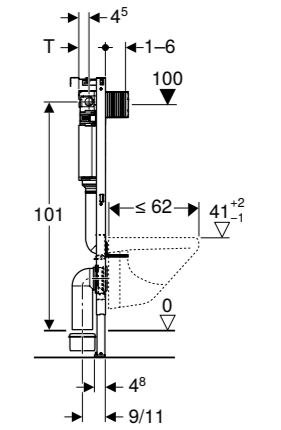
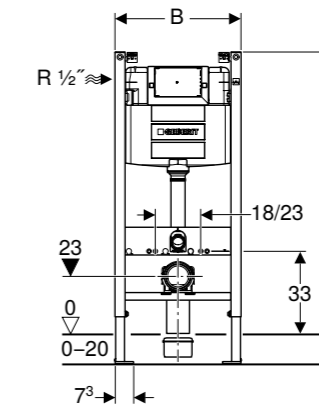

CHANNEL THE WATER AWAY
SAFELY AND QUICKLY



← Geberit traps for washbasins and Kitchen sinks are designed for optimised flow. The traps for washbasins and Kitchen sinks offer a high discharge rate as well as a considerable self-cleaning effect which prevents clogging.

GEBERIT TRAPS FOR WASH BASINS

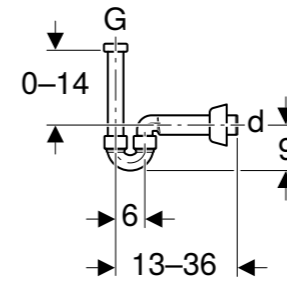
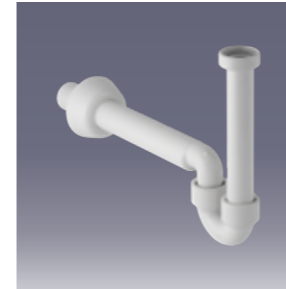

Article No.: 151.108.11.1
Finish: Alpine white
Size: 40 mm
MRP: ₹1,030

Article No.: 151.108.21.1
Finish: Bright chrome
Size: 40 mm
MRP: ₹4,650

Article No.: 151.113.11.1
Finish: Alpine white
Size: 32 mm
MRP: ₹1,030

APPLICATION PURPOSE

• For washbasin • Allows for flexible length & placement

SCOPE OF DELIVERY

• Inlet connector with union nut • Connection bend • Wall collar

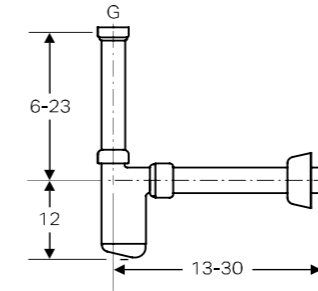

Article No.: 170.103.11.1
Colour: white, 32 mm
MRP: ₹1,270



Article No.: 151.116.11.1
Colour: white alpine, 32 mm
MRP: ₹2,580

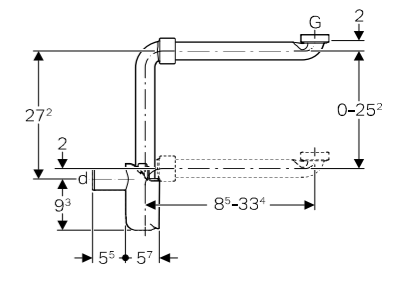

Article No.: 151.117.11.1
Colour: white alpine, 40 mm
MRP: ₹2,580

APPLICATION PURPOSE

• For washbasin • Allows for flexible length & placement

SCOPE OF DELIVERY

• Seals • Connection bend with collar



Article No.: 151.034.11.1
Colour: white, 32 mm
MRP: ₹2,360

Article No.: 151.035.11.1
Colour: white, 40 mm
MRP: ₹2,360

Article No.: 151.034.21.1
Colour: chrome plated
hi-gloss, 32 mm
MRP: ₹3,610

Article No.: 151.035.21.1
Colour: chrome plated
hi-gloss, 40 mm
MRP: ₹3,610

SCOPE OF DELIVERY

• Odour trap
• Inlet pipe with union nut
• Rosette
• Outlet pipe with rosete
• Seals

APPLICATION PURPOSE

• For washbasin

GEBERIT TRAPS FOR KITCHEN SINKS

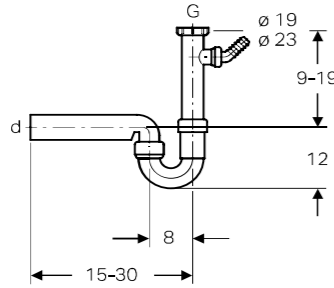

Article No.: 152.713.11.1
Colour: White alpine, 40 mm
MRP: ₹1,270

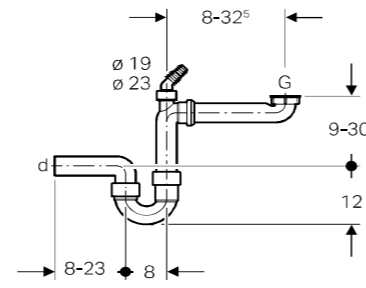

Article No.: 152.885.11.1
Colour: White alpine, 40 mm
MRP: ₹1,700

APPLICATION PURPOSE

- For connecting kitchen sinks with one bowl
- Allows for flexible length & placement

SCOPE OF DELIVERY

- Inlet connector with union nut made of PP, G 1", with supplementary connection
- Angled hose connector made of PP, 19 / 23 mm
- Blind cap for waste coupling G 1"

GEBERIT AFTER SALES SERVICE

COMMITTED TO SERVE YOU



Geberit Trained Technicians equipped with Geberit Service App



10 Years Warranty for concealed cisterns



25 Years Spare Parts Availability



Robust Pan-India Service Network



Value added services like Service Camps, Onsite Plumbing Training etc.



**KNOW
HOW
INSTALLED**

Time: 9am - 6pm. Monday - Saturday.
For Service Warranty registration visit www.geberit.in/service
For any queries email contactgeberit@transactglobal.com
Geberit Plumbing Technology India Pvt. Ltd.

Call Toll Free: 1800-102-4323



Swiss engineering skills are legendary
- and Geberit is a good example
of these. Precision, know-how and
pleasure in innovation characterize
Geberit products and systems, and
have been creating quality of life for
generations since 1874.

Geberit Plumbing Technology
India Private Limited
At The LaLiT Ashok
Kumara Krupa High Grounds,
Bengaluru 560 001
India
CIN no : U41000KA2005PTC036146

T +91 80 39251101
F +91 80 39251133
sales.in@geberit.com
www.geberit.in

Branches
New Delhi +91 11 2735 4723
Mumbai +91 22 6671 3621
Pune +91 20 6562 1100

For service support:
contactgeberit@transactglobal.com

Toll Free 1800 102 4323
Timing: 9am to 6pm (Monday-Saturday)
Closed on Sundays and Public Holidays