



effe

PERFECT WELLNESS
BY EFFGIBI



QUATTROLUXE

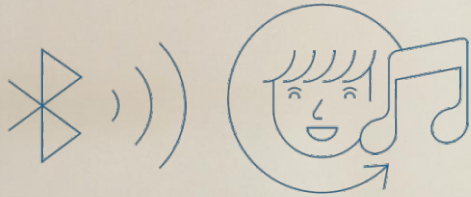

Light fixture with colour therapy and Loudspeakers

You can listen to your favourite music inside the sauna or hammam using a Bluetooth connection and your own device. The Effe Sound System, which has two stereo speakers, connects automatically to the internal speaker with no need to install any software or make special connections.



ESS - Effe Sound System Kit with colour therapy, white light and Bluetooth speakers

There is a choice of five fixed colours (red, yellow, green, blue, aquamarine) and four programs providing tonal variations within one colour range (dawn, sunset, sea, forest).

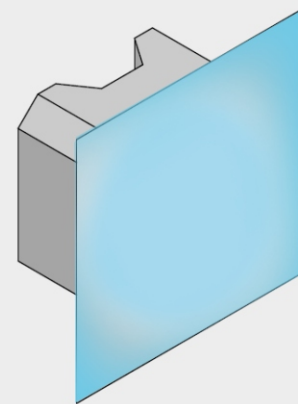
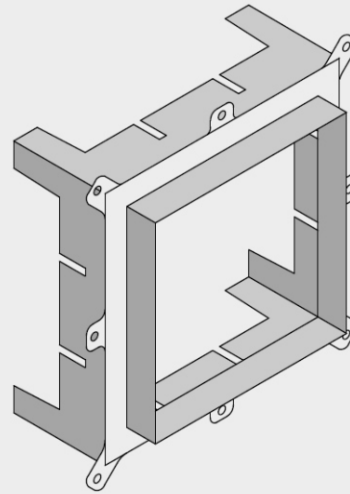
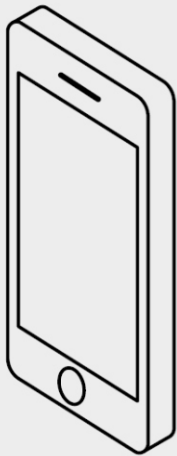

The special doors created by Effe for Hammams are designed to ensure a perfect seal against the escape of steam thus ensuring proper air circulation.

SPAZIOFILO

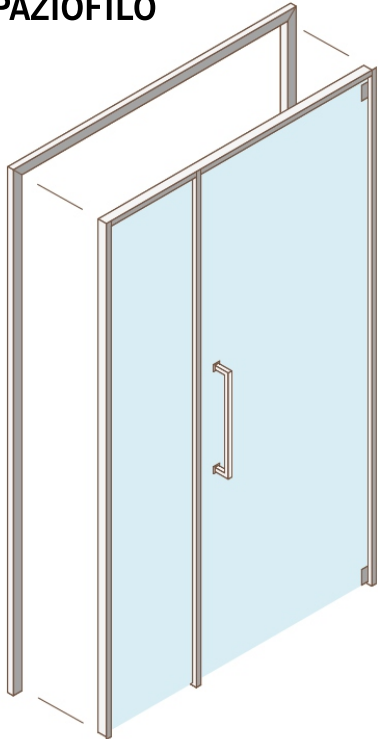

SPAZIO

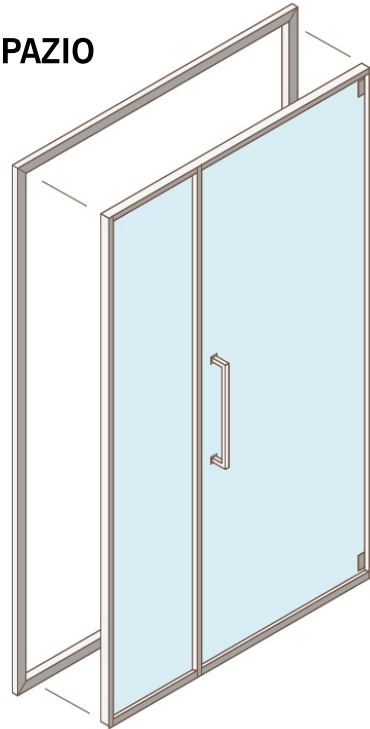

TUTTOVETRO
CONTOUR

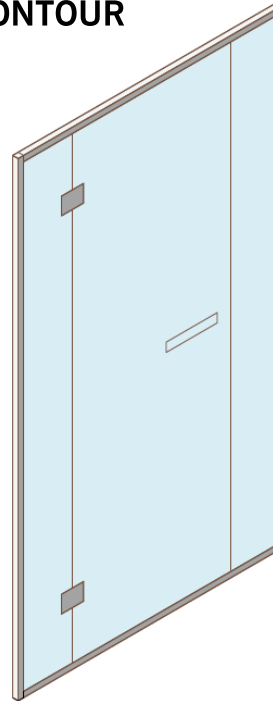

FIT

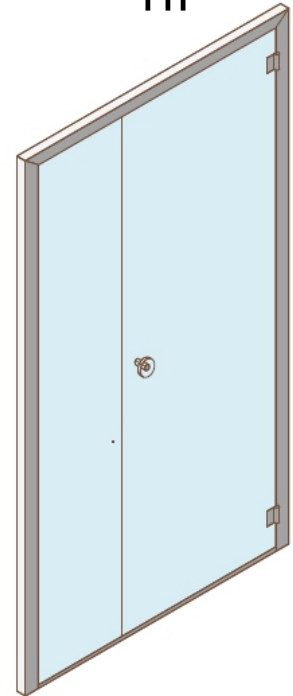

MATERIALS

- › Brushed aluminium finish edges (brushed aluminium, anodised black)
- › Transparent 8 mm toughened glass

FEATURES

- › Classic pull-open door
- › Flush with the flooring
- › Right or left-opening options
- › Lower ventilation



FIT 65
L 65 CM
H 190 CM



FIT 80
L 80 CM
H 210 CM



**FIT 50
GLASS PANEL**
L 50 CM
H 210 CM

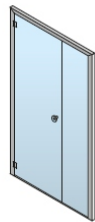

FIT A 120
L 120 CM
H 210 CM



FIT B 120
L 120 CM
H 210 CM



MATERIALS

- › Aluminium frame
- › Cover in Shiny stainless steel
- › Shiny stainless steel handle
- › Transparent 8 mm toughened glass

FEATURES

- › Classic pull-open door
- › Reversible
- › Fitted to counterframe
- › Lower ventilation



SPAZIO 80
L 80 CM
H 200 CM



SPAZIO 120
L 120 CM
H 200 CM



SPAZIO 160
L 160 CM
H 200 CM



**SPAZIO 40
GLASS PANEL**
L 43 CM
H 200 CM



**SPAZIO 80
GLASS PANEL**
L 83 CM
H 200 CM



MATERIALS

- › Aluminium frame
- › Cover in Shiny stainless steel
- › Shiny stainless steel handle
- › Transparent 8 mm toughened glass

FEATURES

- › Classic pull-open door
- › Flush with the flooring
- › Right or left-opening options
- › Fitted to counterframe
- › Lower ventilation

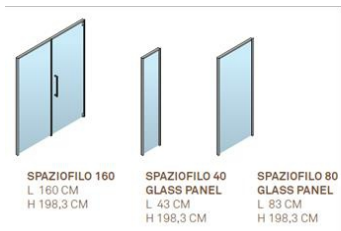

MATERIALS

- › Edges in aluminium with a shiny finishing
- › Edges in brushed-finish aluminium
- › Edges in aluminium with a brushed black anodised finish

FEATURES

- › Heights until 219 cm: transparent 8 mm toughened glass
- › Heights from 220 cm and over: glass thickness 10 mm

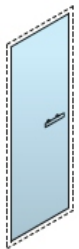
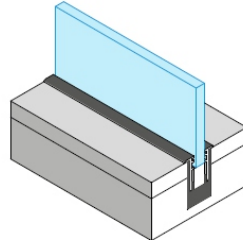

MOD. A
DOOR

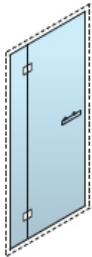

MOD. B
GLASS PANEL -
DOOR -

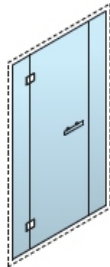

MOD. C
GLASS PANEL -
DOOR -
GLASS PANEL

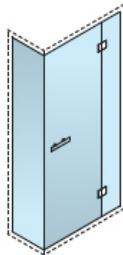

MOD. D
CORNER GLASS
PANEL -
DOOR

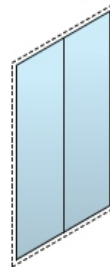

MOD. E
GLASS PANEL



effe

PERFECT WELLNESS
BY EFFEGIBI



QUATTROLUXE